

How do you feel before the network meeting?

Use Annotation tool/ Chat

CA – accounting function network meeting

12 October 2022 | Online, Zoom

Welcome!



Orsolya



Iuliia

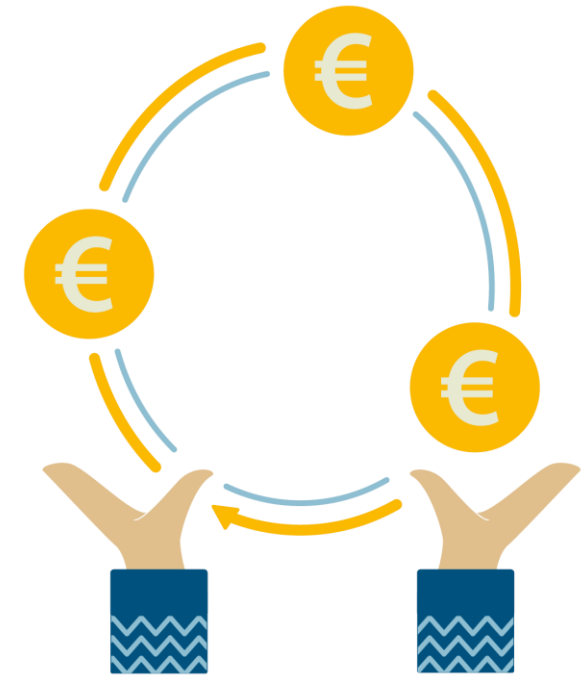

Agenda

Time	Content
09.15 – 09.30	Welcome & Onboarding
09.30 – 10.00	Legal framework 2021-2027 - updates
10.00 – 10.45	Programme closure 2014-2020 - implications for the CA
10.45 – 11.00	Comfort break
11.00 – 11.15	Scenarios for treatment of irregularities
11.15 – 11.45	Audit and the accounting function – summary
11.45 – 12.30	Topics from the registration
12.30 – 12.45	Closure of the meeting

Objectives

- To provide an overview of the state of play of the legal framework 2021-2027 and relevant information from Interact;
- to exchange and provide information on the programme closure 2014-2020 (following the [dedicated event](#) on closure);
- to exchange on key requirements checklists, system audits, assurance package;
- to discuss the roadmap for the assurance package in 2021-2027;
- next steps.



Pre-agreements

- Stay ‘muted’, unless talking
- Contribute & share – network meeting
- Be open
- Be patient with others
- Questions/contributions: use chat/ raise “virtual hand” and speak up

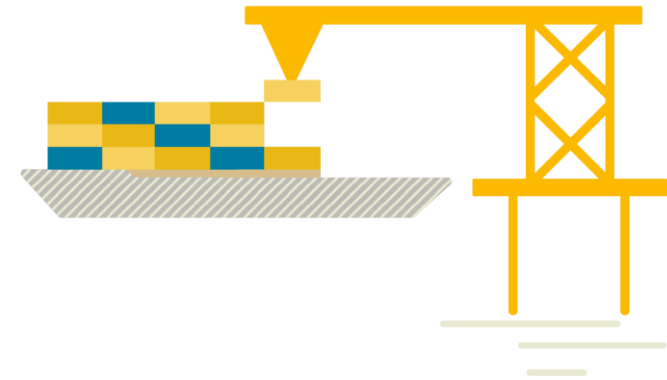

Statistics from the registration

- 49 programmes (11/20/2022)
 CBC - 33; TN - 10; Int - 3; IPA-CBC - 3.

- How will the accounting function be organised in your programme in 2021-2027?

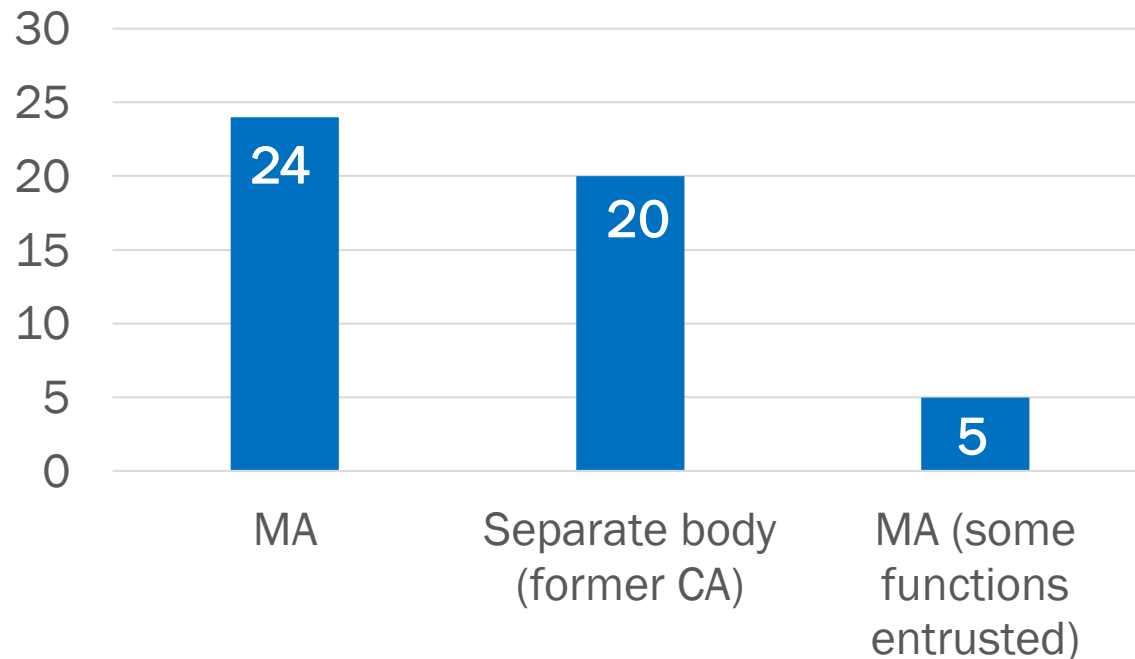

State of play and few updates

Accounting function in CPR and Interreg Regulation



Updates on the legislative package 2021-2027

- As of September 2022, 30 Interreg programmes are adopted by the EC:
 - 21 cross-border;
 - 6 transnational;
 - 3 interregional;
 - no IPA-CBC programmes adopted;
 - no NEXT-CBC programmes adopted (7 are submitted to the EC).



Suspension of cooperation programmes with Russia and Belarus

- March 2022 – suspension of cooperation with Russia and Belarus in 9 ENI-CBC programmes and BSR (no further payments to Russia and Belarus).
- Cooperation with both countries under the 2021-2027 period is suspended too.
- 22 March 2022 - a meeting in Brussels to explore ways to continue the implementation of concerned ENI CBC programmes. As a result, it was understood that the EU beneficiaries can carry on the project operations, whereas the activities and financial flows on the Russian and Belarusian sides have to be suspended.
- Strengthening cooperation with Ukraine (CBC programmes, Danube, Black Sea Basin) and Moldova – especially after granting a candidate status for EU membership to Ukraine (23.06.2022).
- 3 June - the EC proposed to transfer €26.2m from the NDICI, originally earmarked for the 2021-2027 Interreg NEXT programmes with Russia and Belarus, to the same programmes with Ukraine and Moldova.



Updates on the legislative package 2021-2027

- [NDICI Regulation](#) – Jun 2021 (Regulation (EU) 2021/947)
- [IPA III Regulation](#) - Sep 2021 (Regulation (EU) 2021/1529)
- The [IPA III programming framework](#) - adopted in Dec 2021
- EC adopted 2 Implementing Acts (Articles 8 and 11 IR) – Jan 2022:
 - => [Commission Implementing Decision 2022/74](#) with the list of Interreg Programmes and global allocations for each programme (Article 11)
 - => [Commission Implementing Decision \(EU\) 2022/75](#) with the list of Interreg programme areas receiving support (Article 8)
- [NDICI multiannual strategic document](#) adopted in Aug 2022



Updates on the legislative package 2021-2027

- Figures in the Implementing Decision ([2021/1131](#) as of July 2021 – annual breakdown of global resources) – 2 tables:



Global amounts of the total support ≠ Amounts available for programming

- Global amounts of the total support = Amounts agreed by the Council and Parliament expressed in 2018 prices
- Amounts available for programming = 2018 prices indexed by 2% each year less amounts transferred for EU-wide activities

Updates on the legislative package for 2021-2027

Annual breakdown of global resources by MS under the ETC goal (Interreg in Implementing Decision 2021/1131 of 5 July 2021)

EUR 2018 prices

	2021	2022	2023	2024	2025	2026	2027	Total
Belgium								
Bulgaria								
...								
Total	1 150 000 000	1 150 000 000	1 150 000 000	1 150 000 000	1 150 000 000	1 150 000 000	1 150 000 000	8 050 000 000

EUR current prices

	2021	2022	2023	2024	2025	2026	2027	Total
Belgium								
Bulgaria								
...								
Total	1 220 389 202	1 244 796 985	1 269 692 924	1 295 086 781	1 320 988 519	1 347 408 289	1 374 356 454	9 072 719 154

Pre-financing 2021 and 2022

- No distinction between "initial" and "annual" pre-financing
- Pre-financing % - Article 51 IR (1% - 2021 and 2022, 3% - 2023-2026)



Clearing of pre-financing

- Pre-financing 2021 and 2022 – cleared by accounting year (similar to former annual pre-financing);
- Pre-financing 2023-2026 – cleared at closure at the latest (similar to former initial pre-financing)

Impact of programme adoption on clearing

Scenario 1:

Programmes adopted in the first half of 2022



- Pre-financing 2021 and 2022 will be paid in the **1st** accounting year (01/01/2021 – 30/06/2022)
- Pre-financing 2021 and 2022 will be cleared in 2023 (double clearing): 100% offsetting against PF 2023 and a net recovery of up to 1 pre-financing

Scenario 2:

Programmes adopted in the second half of 2022



- Pre-financing 2021 and 2022 will be paid in the **2nd** accounting year (01/07/2022 – 30/06/2023)
- Pre-financing 2021 and 2022 will be cleared in 2024 (double clearing): 100% offsetting against PF 2024 and a net recovery of up to 1 pre-financing*

*PR 2023 cleared at closure!

Overview of pre-financing payments

	Programmes adopted in the 1st half of 2022	Programmes adopted in the 2nd half of 2022
Y2022	PF 2021 & PF 2022	PF 2021 & PF 2022
Y2023	PF 2021 offset against PF 2023 PF 2022 recovery (limited by submission of interim claims)	PF 2023
Y2024	PF 2024	PF 2021 offset against PF 2024 PF 2022 recovery (limited by submission of interim claims)

[Source: CPR Expert Group](#)

It is not possible to decline pre-financing of 2021 (even though programmes are adopted starting with 2022). Pre-financing amounts are then offset against next pre-financings.

Discussion

- Are there programmes that were approved in the 1st accounting year (01.01.2021 – 30.06.2022) and got their pre-financing for 2021 and 2022 in the 2nd accounting year (01.07.2022 – 30.06.2023)?
 - A programme adopted in the first half of 2021 (1st accounting year), got pre-financing for 2021 and 2022 in September 2022 (so technically it's 2nd accounting year). Pre-financing cleared in 2023 (scenario 1) or in 2024 (scenario 2)?

Decommitment targets in 2021-2027 (N+3)

- Timing of programme's adoption affects the way decommitment targets are set;
- No Interreg programmes were adopted in 2021;
- No Interreg programmes had inter-service consultations finalised by the end of 2021 – reprogramming mechanism (no carry-over mechanism);
- A new financial plan with 2021 allocation split into 4 equal tranches over 2022 – 2025 should be submitted – 25% of the 2021 allocation is added to each of the following 4 years;
- Financial allocations start from 2022;
- Decommitment targets start from 2025: 1st decommitment target is increased by 25% of the 2021 allocation (2025 target – 2022 allocation + 25% of the 2021 allocation)



Decommitment targets in 2021-2027



- All programmes must be adopted by the end of 2022
- If not adopted, the 2021 allocation will NOT be reprogrammed and will be lost for the programme!
- IF inter-service consultation is finalised by the end of 2022 – carry-over procedure (programme to be adopted by March 2023)
- Decommitment mechanism – Article 105-107 CPR (Interreg, IPA-CBC programmes)

Template to calculate your programme's decommitment targets in 2021-2027



Template | Calculate your decommitment targets in 2021-2027

Fields of expertise: Decommitment

Date Published: 18/07/2022

Author: Interact Programme

Rate this



Total votes: 0

[Comment this](#)

- To be used by Interreg programmes (TN, CBC, INT)
- To be used by IPA-CBC programmes (TN and CBC)
- Not for NDICI programmes

Calculator to programme your programme's TA in 2021-2027



Calculator | Programme your TA 2021-2027

Fields of expertise: Interact IV 2021 - 2027

Date Published: 21/10/2021

Author: Interact Programme

Rate this



Total votes: 0

[Comment this](#)

Share this:

- To be used by all Interreg programmes (Interreg, IPA-CBC, NDICI programmes) – several tabs available (to fill in Table 8 of Interreg programme document)
- For all budget sizes programmes
- + [Factsheet on TA in 2021-2027](#)

Challenges connected with the TA flat rate in the first years



- First years' of programme implementation – cash flow challenges
 - Remedy: pre-financing (but cleared for the years 2021-2022)
 - Get national contributions for the TA in full at the beginning
 - Making use of savings from previous periods (Art 59 CPR: TA actions financed may concern previous and subsequent programming periods)
- Dependence on the projects' spending
 - Careful budgeting, planning and monitoring as TA is constantly “on the move”
- How to ensure receiving 100% of TA?
 - Ensuring high project spending level (overcommitment)
 - Budgeting TA on the lower scenario of projects' spending (e.g., 90%)

Questions, remarks, comments?



Scenarios for treatment of irregularities

5 scenarios to be included in Jems



Roadmap for the assurance package in 2021-2027

September 2022



Disclaimers

- 5 scenarios presented in the Roadmap concern irregularities found in the accounting year they were declared.
- Scenarios do not concern irregularities found from the previous (closed) accounting years.
- Scenarios do not concern other corrections than irregularities (e.g., flat rate corrections, mistakes, adjustments not related to irregularities, etc.).



Scenario 1 - An irregularity (EU contribution part) is below EUR 250. The amount should be below EUR 250 per project in an accounting year.

- No correction in the accounts or payment applications is needed (the EC only has to be notified of the programme's decision not to recover the amounts).
- It is important to have a system in place that allows checking whether the cumulative amounts of such irregularities do not exceed the EUR 250 threshold. If several irregularities are found in the same project in the same accounting year (even if irregularities are not related and stem from different project partners), the overall amount (in contribution from any of the Interreg funds, not including interest) must be under the threshold, for the amounts to be left uncorrected. **Otherwise, Scenario 3 applies.**



Scenario 2 - An irregularity is detected before 31 July (deadline for the submission of the last payment application for the accounting year).

- The amount should be withdrawn in the next interim/ last payment application for the corresponding accounting year.
- If the amount is withdrawn in the next interim/ last payment application, the withdrawn amount should be reported in Appendix 2 of the accounts (Appendix 2 Amounts withdrawn during the accounting year (Annex XXIV CPR).
- Appendix 2 also includes a table for indicating total sums relating to each accounting year (by year of the declaration of the amount), and the amount corrected as a result of audits.
- The MA may also decide to wait until the submission of the accounts. In this case, Scenario 3 applies *(This interpretation is based on the EGESIF note 15_0017-04 on withdrawals and recoveries prepared for 2014- 2020. Should new interpretations for 2021-2027 be available, this assumption might be revised accordingly)* >>> If the MA needs to wait for some reason, the amount must be deducted at the time of submission of the accounts at the latest – in this case, Scenario 3 applies.



Scenario 3 - An irregularity is detected after the submission of the last payment application for the accounting year (after 31 July following the end of the accounting year) but before the submission of the accounts (before 15 February following the end of the accounting year concerned).

- The amount must be deducted from the accounts as a known irregular amount related to the accounting year being reported or a previous accounting year (if the irregularity pertains to the “current” accounting year (for which the final payment application has not yet been submitted), it should be treated as scenario 2 (irregularity identified before 31 July)).
- The deducted amount should be reported in Appendix 4 (not Appendix 2! - Appendix 4 Reconciliation of expenditure (Annex XXIV CPR)) of the accounts as a difference between the eligible expenditure included in the payment applications and the eligible expenditure entered into the accounting systems of the accounting function.
- The reason for the difference should be provided in Column G.
- Appendix 4 also includes a table for indicating the amount corrected as a result of audits (to be filled in if applicable).



Scenario 4 - An irregularity is subject to ongoing assessment at the time of submission of the accounts (e.g., the audit finding is only at the draft report stage).



- The amount must be deducted from the accounts (Article 98(6) CPR).
- The deducted amount should be reported in Appendix 4 of the accounts as a difference between eligible expenditure included in payment applications and eligible expenditure entered into the accounting systems of the accounting function.
- The fact that the deduction is linked to an ongoing assessment must be indicated in Column G. Amounts subject to ongoing assessment may be included in a payment application in a later accounting year if they turn out to be legal and regular. However, to be able to re-introduce such amounts, it must be indicated in Column G that these amounts are still being assessed. Otherwise, previously withdrawn/deducted amounts should not be reintroduced (Based on EGESIF Guidance 15_0018-04 for 2014-2020. Should new interpretations for 2021-2027 be available, this assumption might be revised accordingly).
- If the amount turns out to be irregular (according to the final decision), no further actions are required (the irregularity has already been deducted).
- If the disputed amount arose as a result of audit work, the amount should also be included at the bottom of the table in Appendix 4 as an amount corrected due to audits.

Scenario 5 - An irregularity is detected after the submission of the accounts (Article 98(7) CPR)

- After the submission of the accounts, a new cycle of a new accounting year begins, and subsequent corrections will feature in the new accounts (depending on the stage of the new accounting year in which the irregularity is detected – see previous scenarios).



Accounting year X, irregularity concerns accounting year X, detected in year X

FOUND BEFORE LAST PA

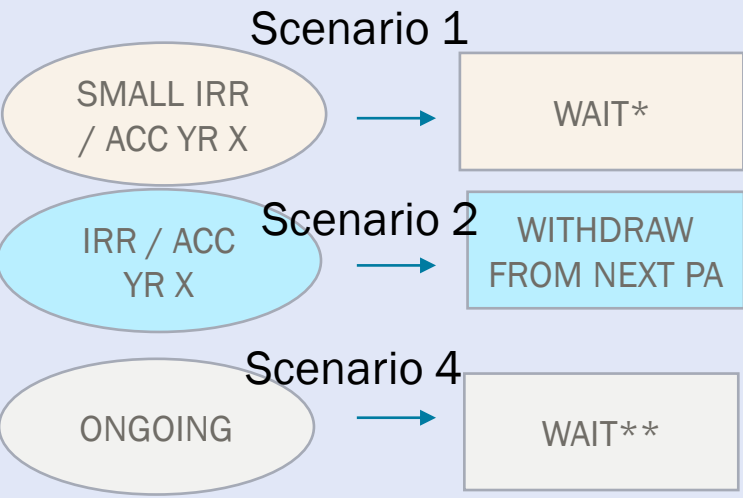

FOUND AFTER LAST PA, BUT BEFORE SUBMISSION OF ACCOUNTS

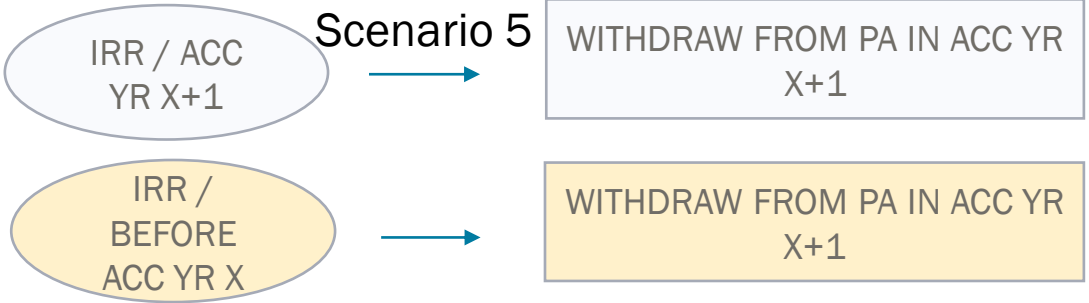
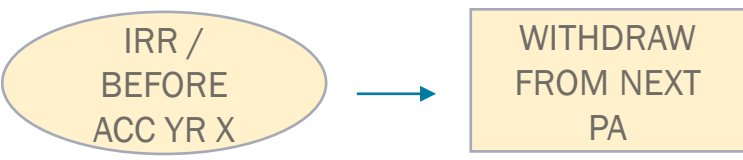
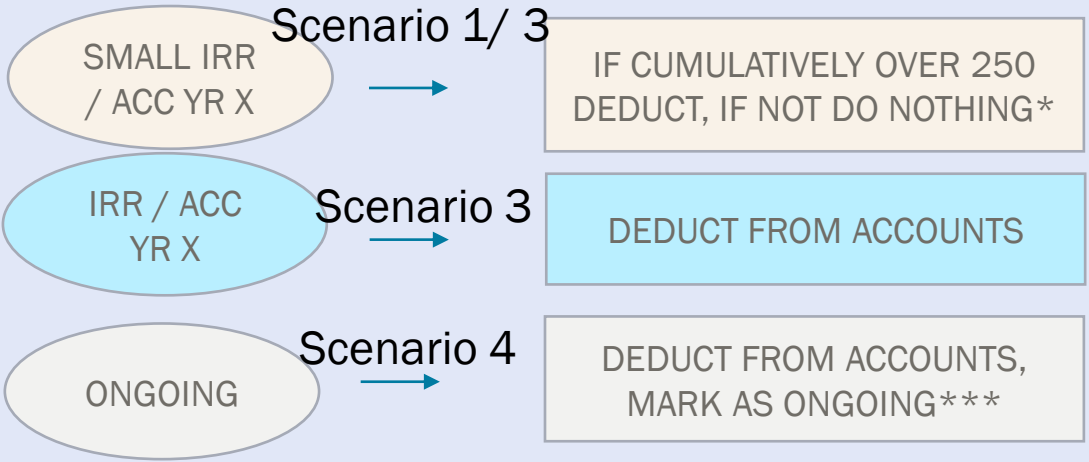

*This scenario only applies if the participating states took a decision not to recover such small amounts (Article 52(2) IR). In case of small amounts, it is proposed here to assess the cumulative impact (once) before submission of the accounts, but continuous checking of the threshold is also possible.

**Withdrawal from the next PA is also an option, but then no reintroduction of the amount is possible later if found legal and regular.

*** If later found to be legal and regular, it may be reintroduced in a later payment application.

Cooperation works

All materials will be available on:

www.interact-eu.net

